

图 1 组件安装的角度

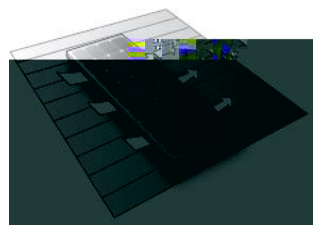

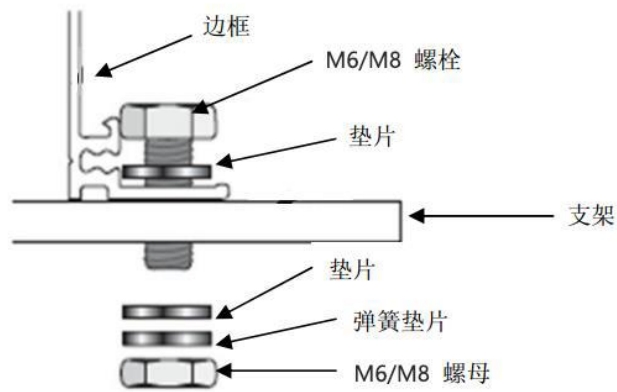

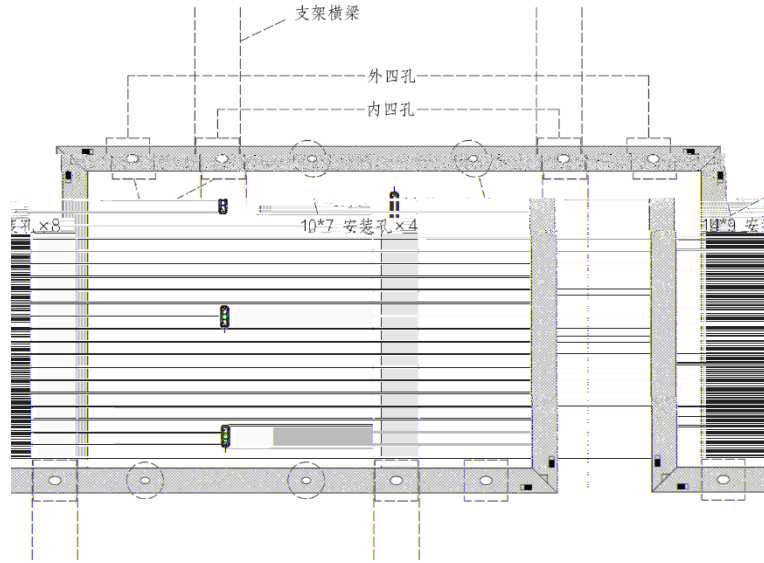

| | | |
|--|--|--|
| | | |
| | | |
| | | |
| | | |
| | | |
| | | |
| | | |

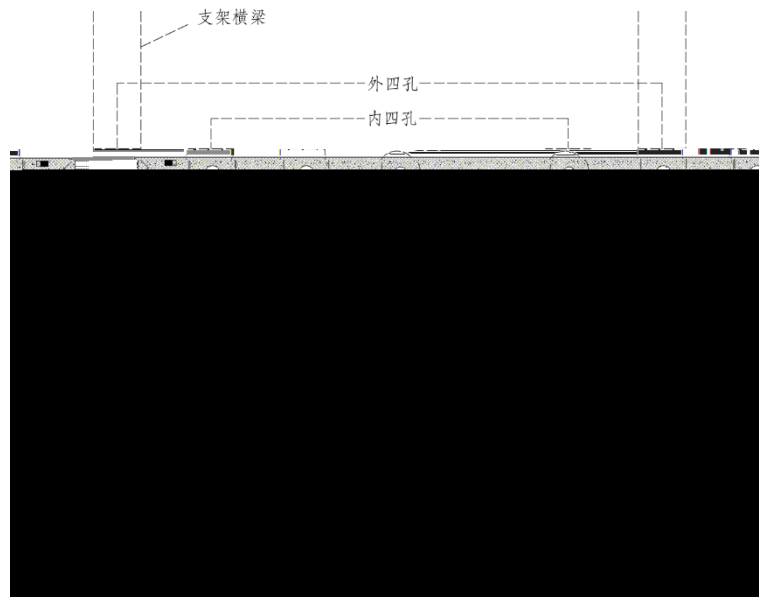

| | | |
|--|--|--|
| | | |
| | | |
| | | |
| | | |
| | | |
| | | |
| | | |

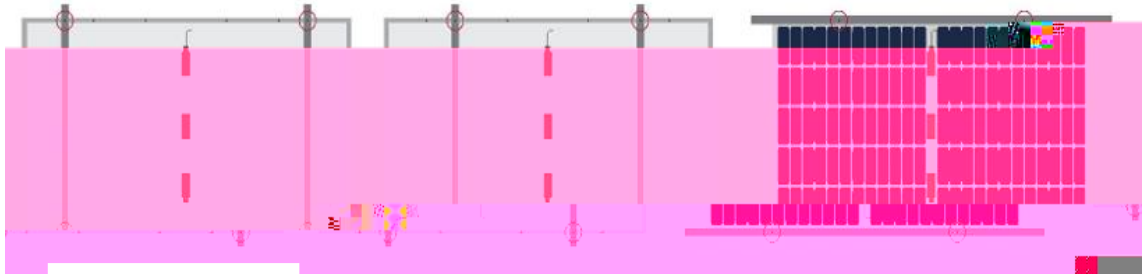

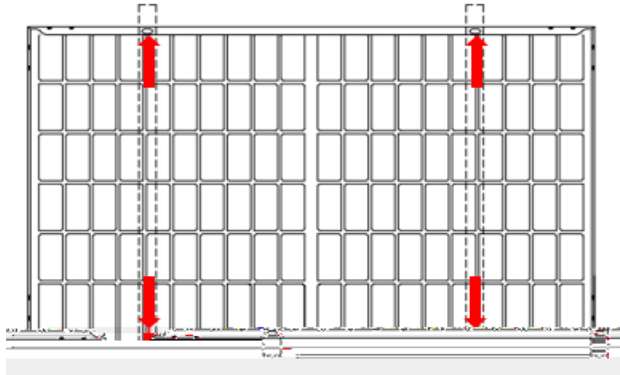
| | | | |
|--|--|--|--|
| | | | |
| | |  | |

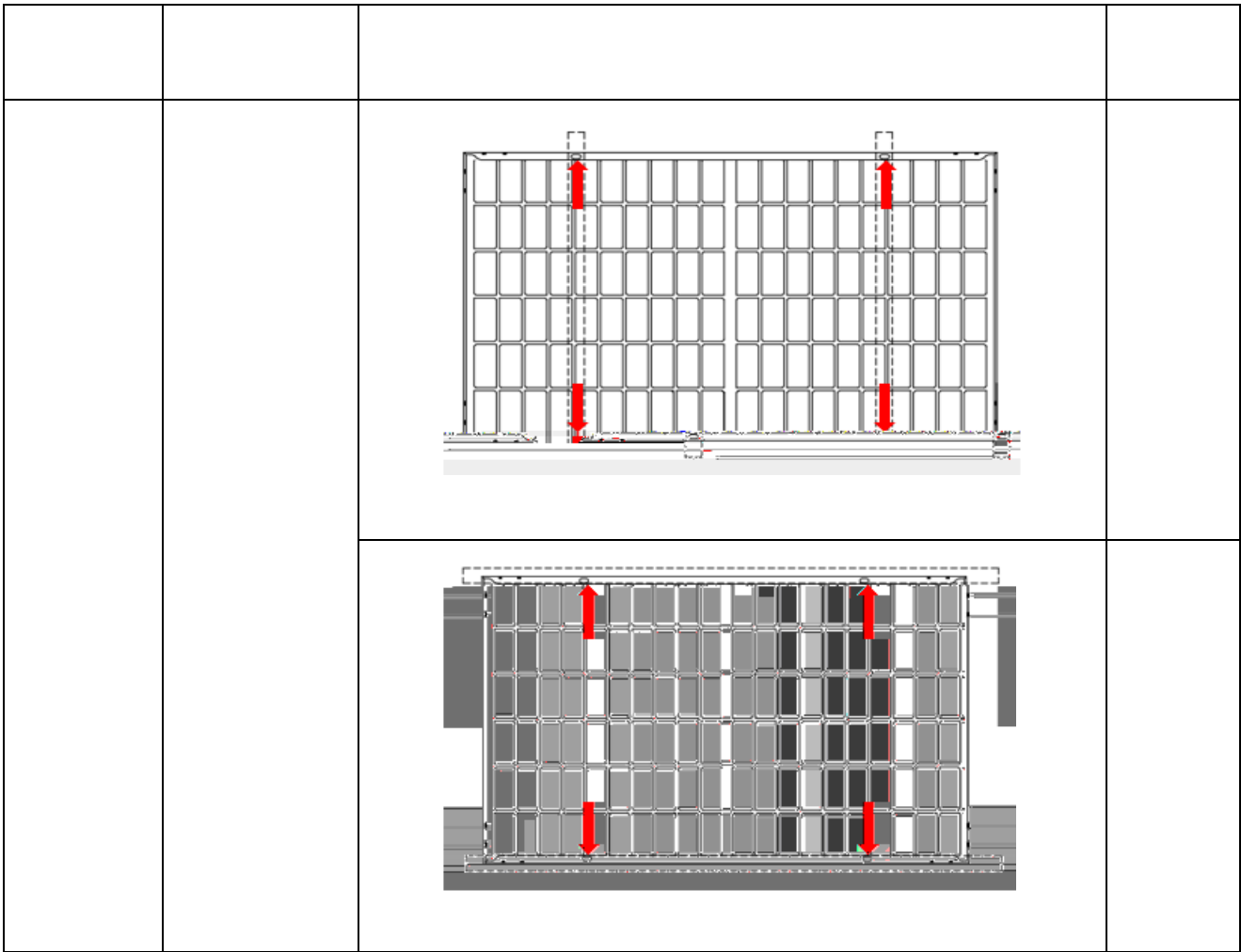
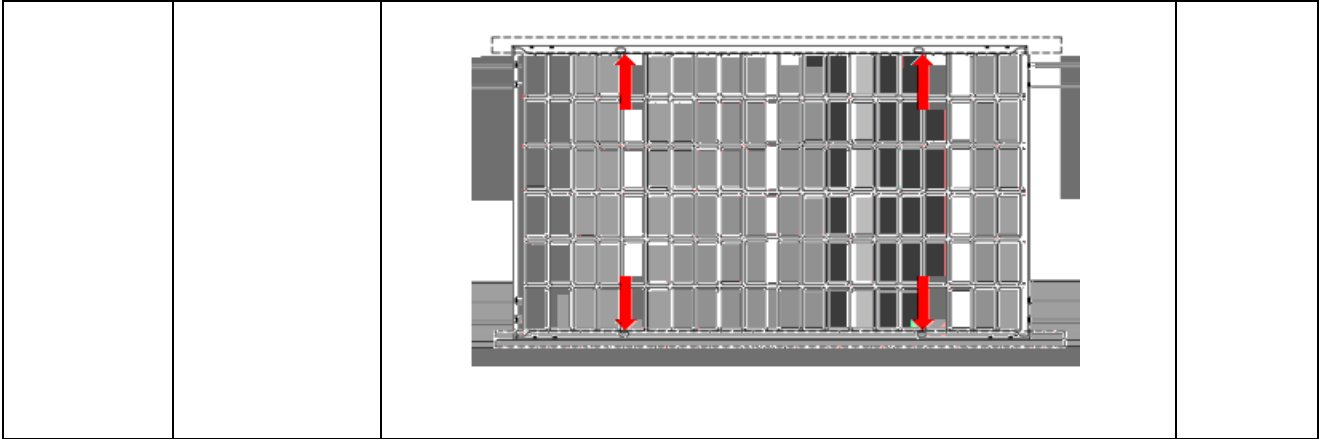

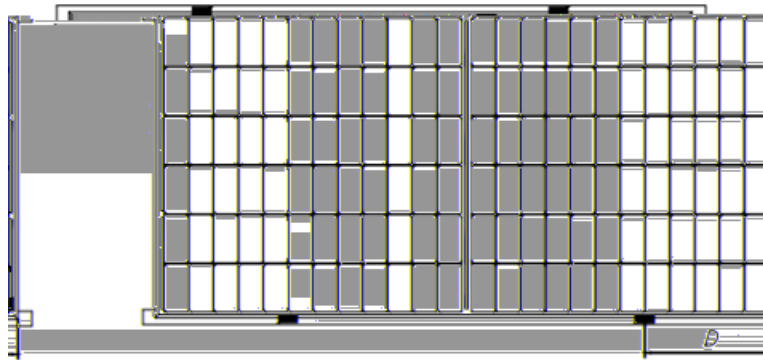
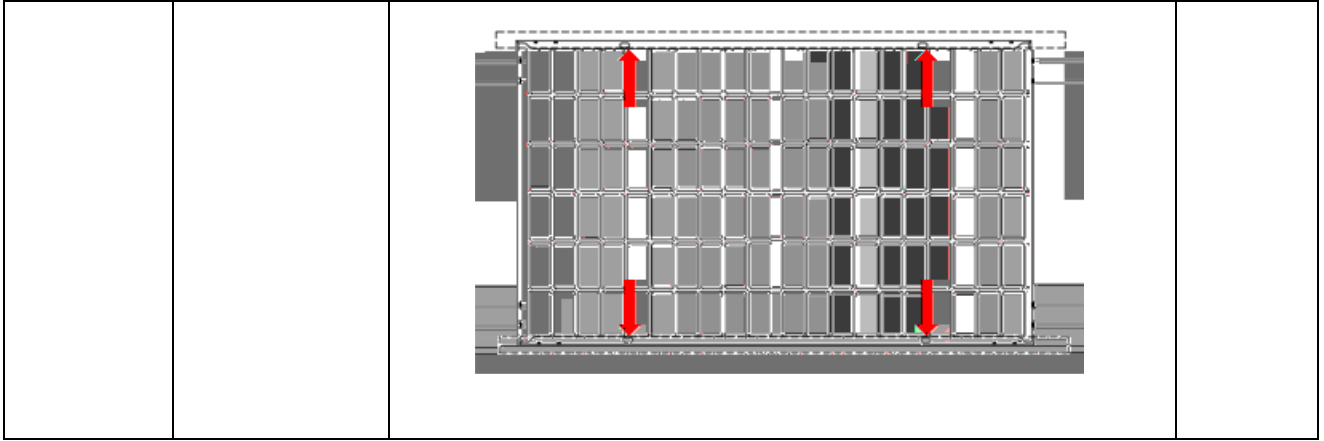

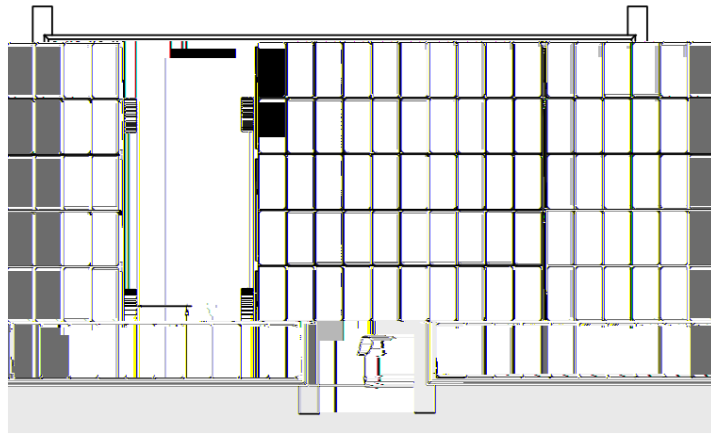

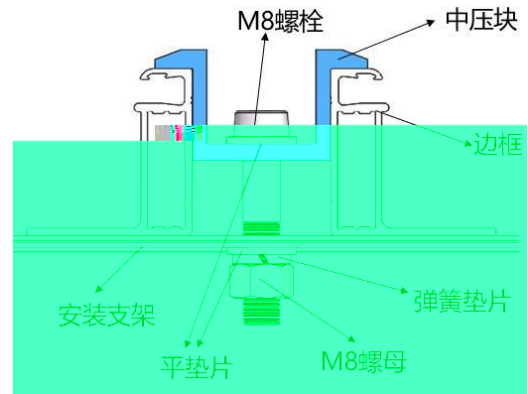
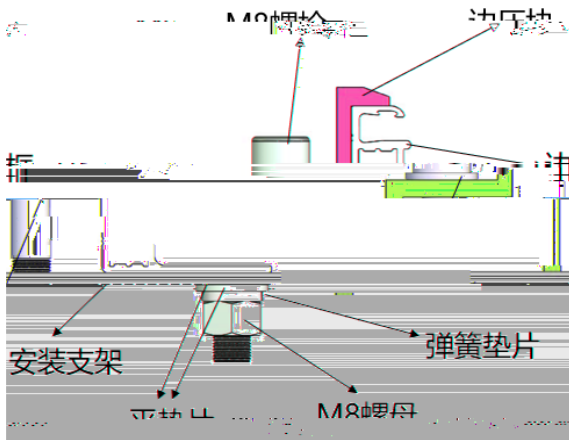
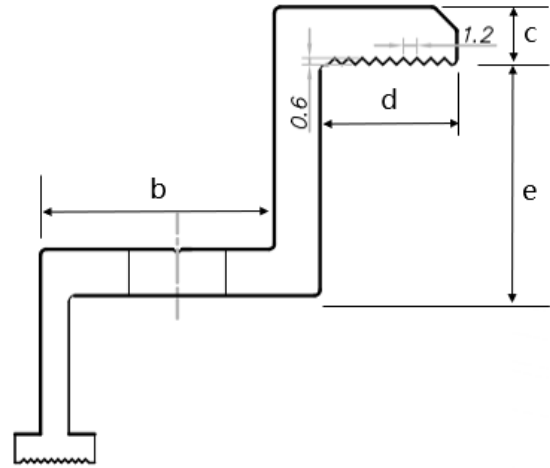
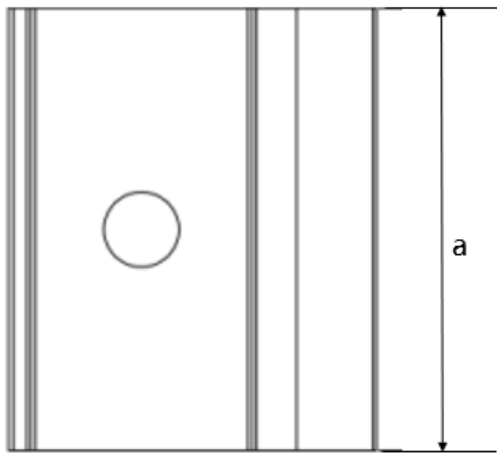

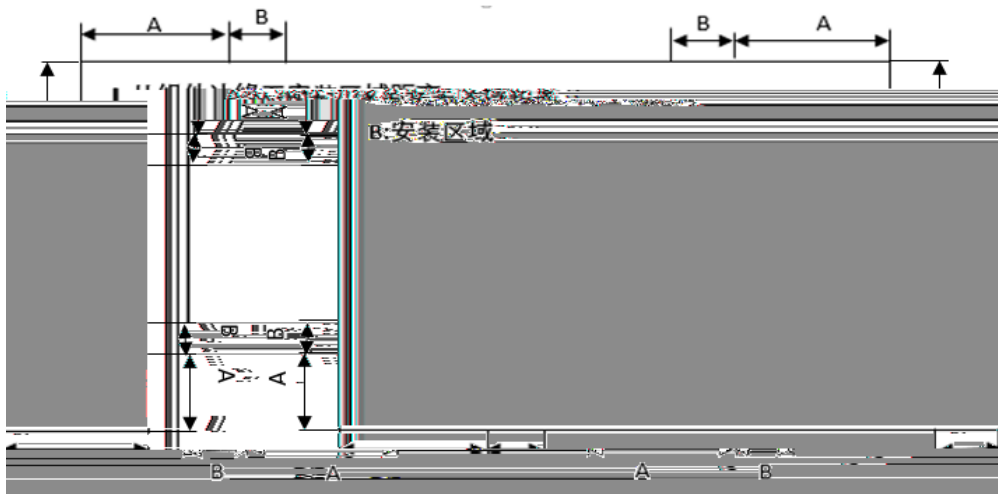

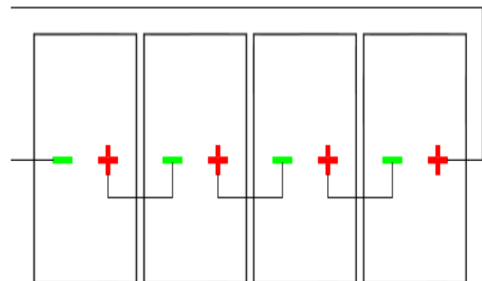
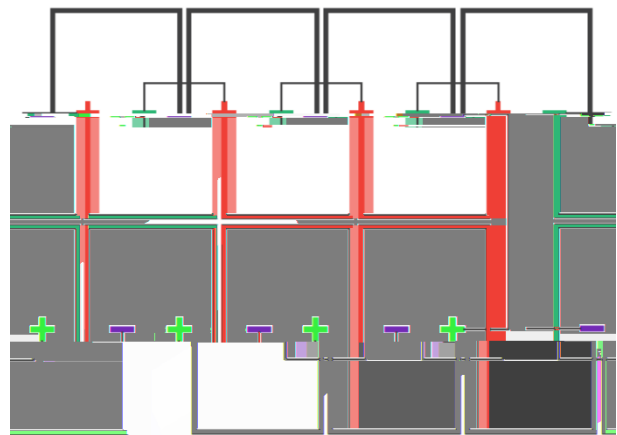

| | | | | |
|--|--|--|--|--|
| | | | | |
| | | | | |

| | | | | |
|--|--|-----|--|-----|
| | | | | |
| | | | | |
| | | | | --- |
| | | | | --- |
| | | --- | | --- |

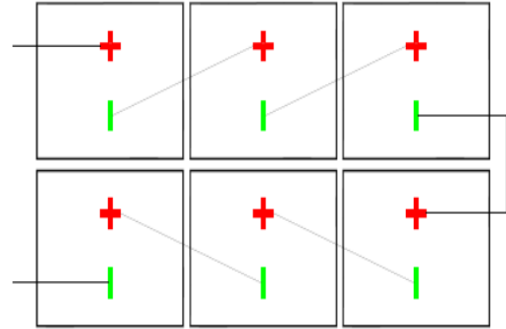



| 零件 | 示图 | 连接方式 |
|---|---|--|
|  |  | <p>将星形垫圈、平垫圈和接地线依次放置，使用螺钉穿过接地孔，再将其拧紧来固定相邻组件。</p> |

2.

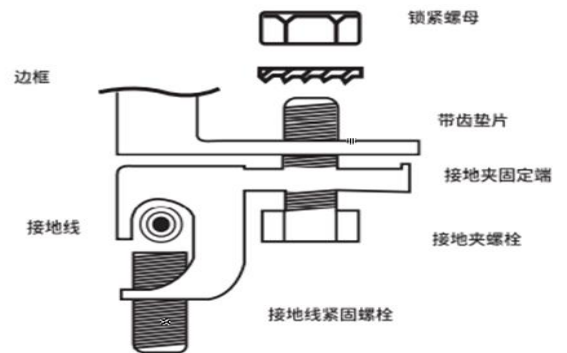

3.

